

Rev.	design change reason	Date	Name
Ver 1.0	Release	2013/08/29	Nancy

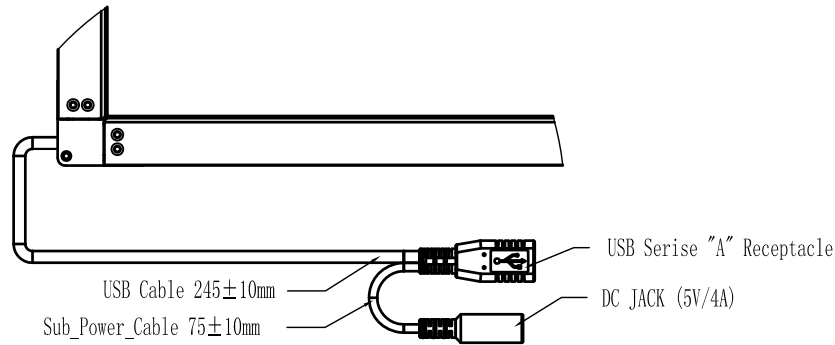
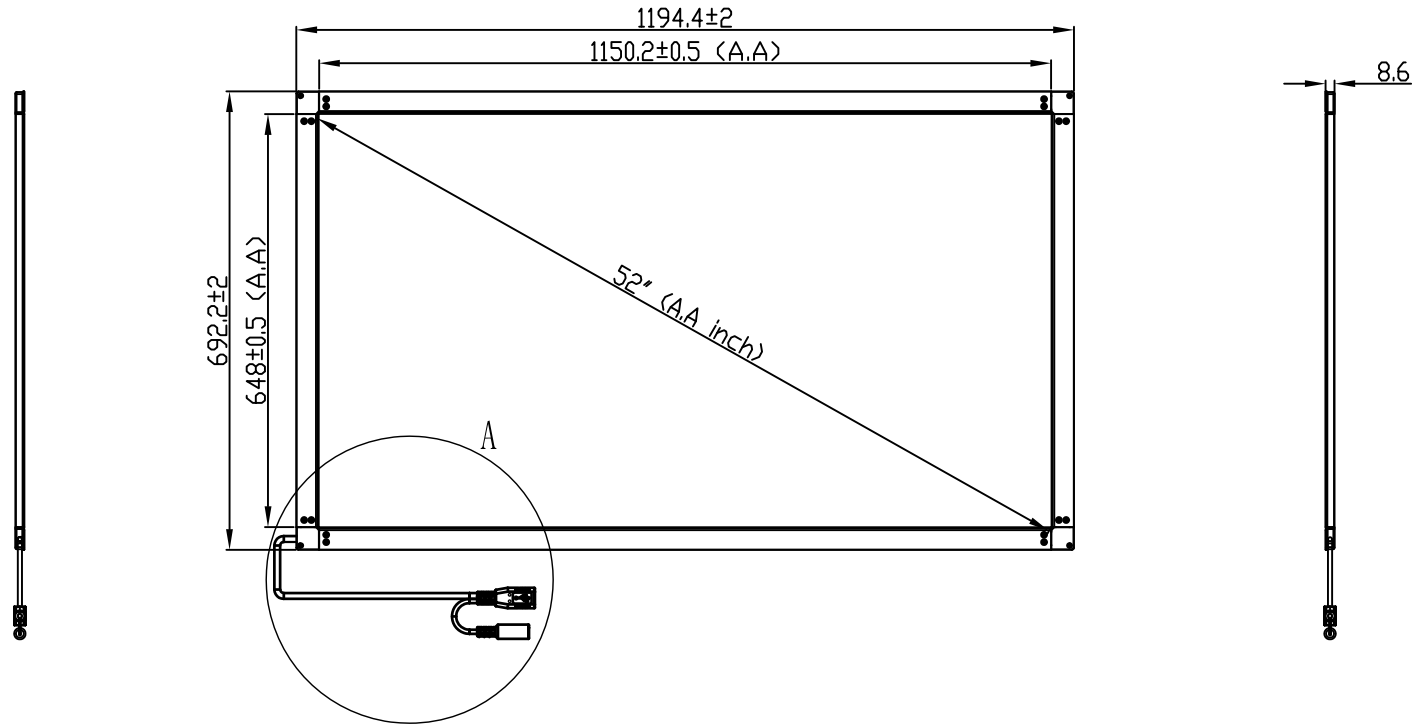

Technical Requirements:  
 1. Dimensionless Units: mm;  
 2. Accords with RoHS standard.

Tolerances		Pos.	Object	Material	Mass	Title
0 ~ 10 (mm)	±0.3	±0.5	Projection	Drawn	Remarks	G4 Kit V2-52" Assembly
10 ~ 50 (mm)	±0.5	±0.8		Check	Scale	
50 ~ 100 (mm)	±1.0	±1.5	Part No.	Drawing frame	AS	Dwg. Nr.
100 ~ (mm)	±3.0	±3.0		Type	Date	Nr./sheet.
Angle	X° ±0.5°		The information contained herein is confidential and proprietary, and any copying redistribution of the information contained here is strictly prohibited without formal/written permission of PQ Labs Inc.			