

Rev.	design change reason	Date	Name
Ver 1.0	Release	2012/09/05	Nancy

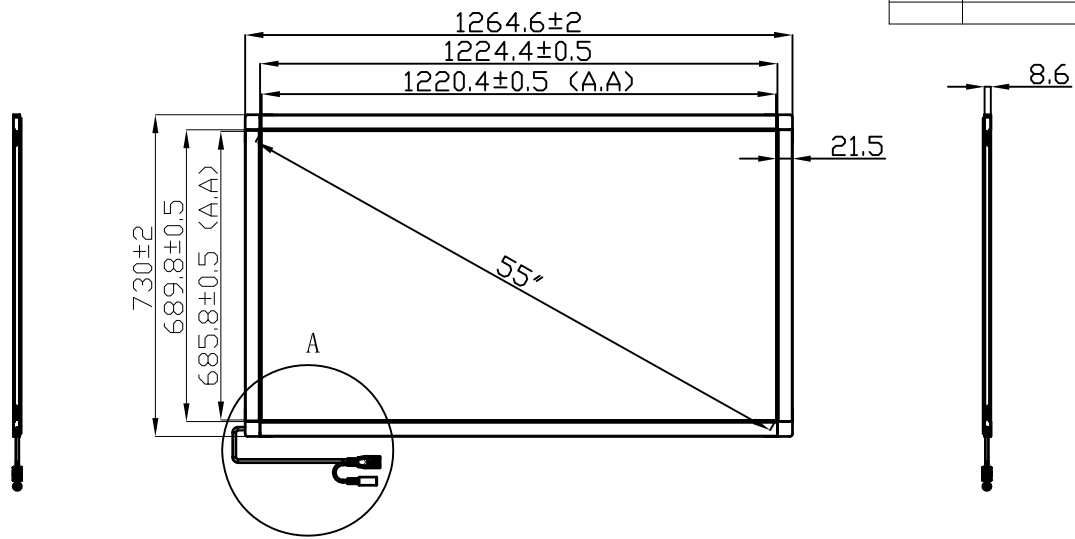

A
1:2

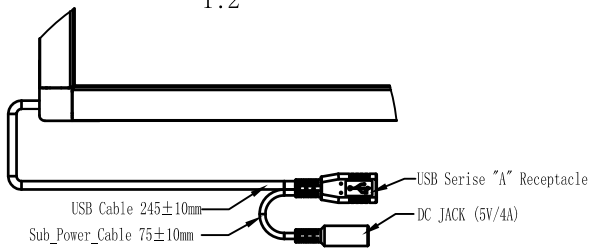

Technical Requirements:
 1. Dimensionless Units: mm;
 2. Accords with RoHS standard.

Tolerances	Pos.	Object	Material	Mass	title
0-10mm	±0.05	Projection	Drawn	Remarks	G4-55" Assembly
10-50mm	±0.1		Checked	Scale	
50-100mm	±0.15	Part No.	Brassing From	Dwg. Nr.	
100-1000	±0.2		Type	Date	
1000-10000	±0.3	The information contained herein is confidential and proprietary, and any copying redistribution of the information contained here is strictly prohibited without formal/written permission of PQ Labs Inc			
10000-100000	±0.5				